

# Spark Gap

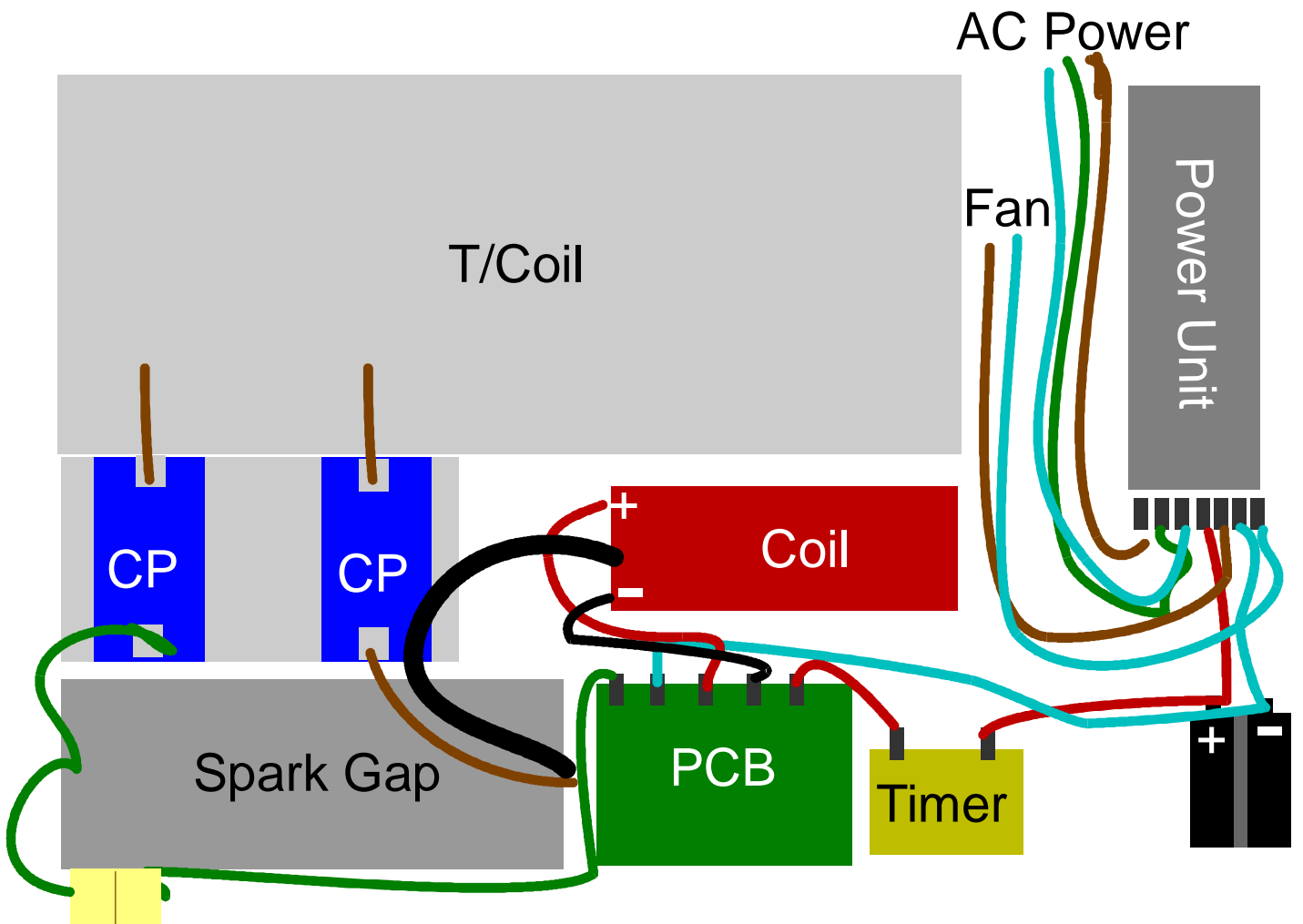

How to remove side cover in order to remove spark gap

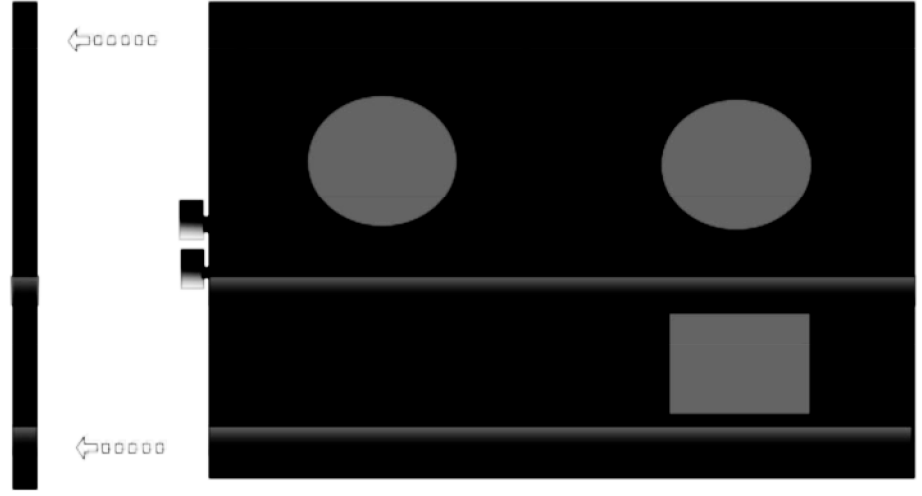

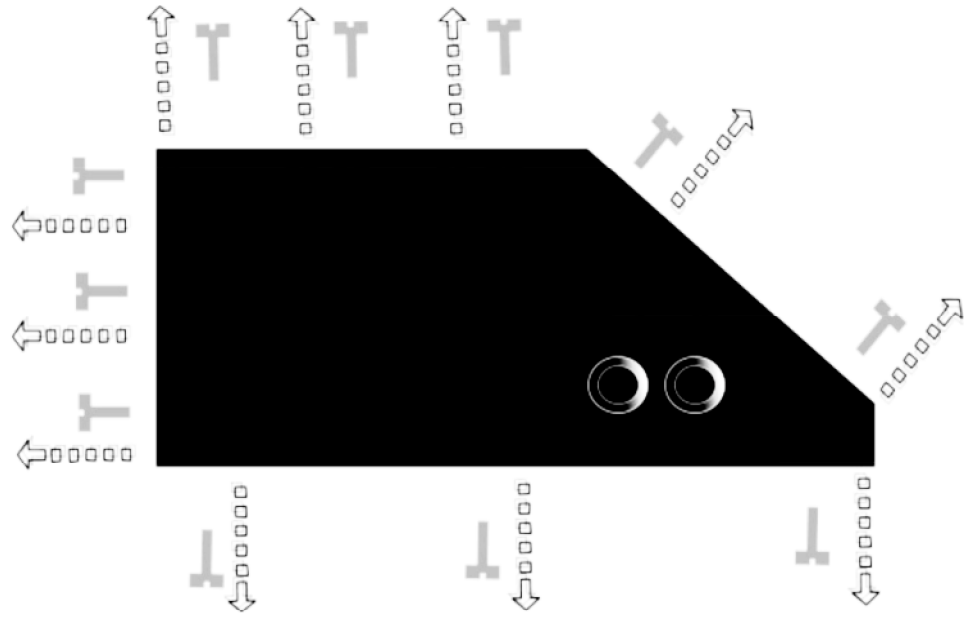
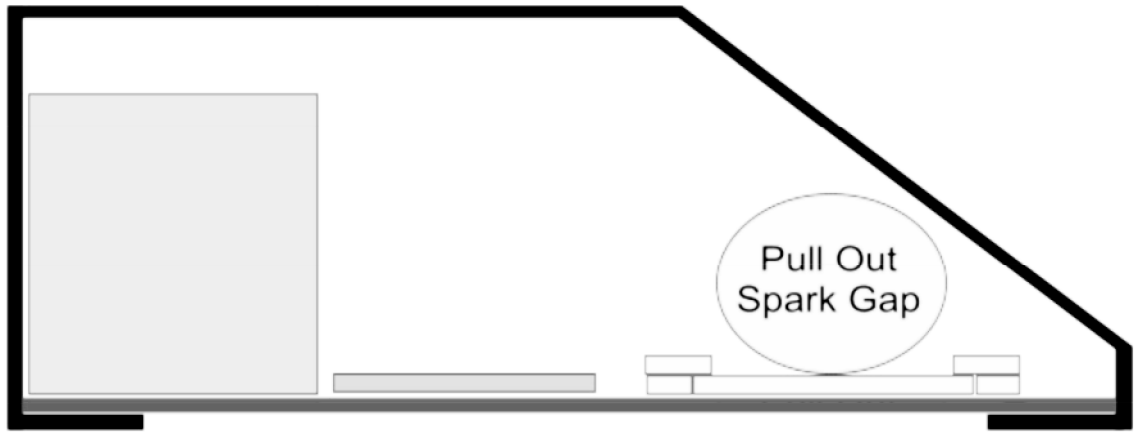

# Spark Gap Cleaning Process

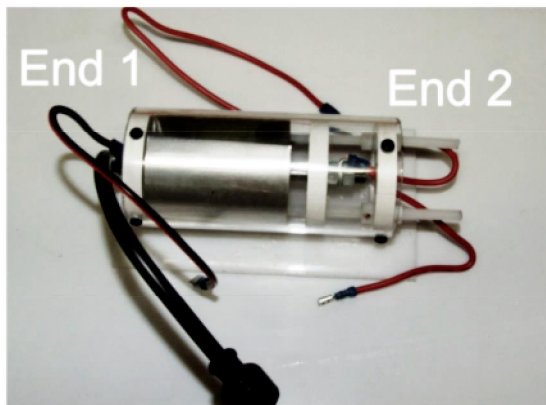

This is the spark gap, as you can see there is end 1 and end 2. When re-assembling these ends must be inserted back into the same ends of cylinder they were taken out of.

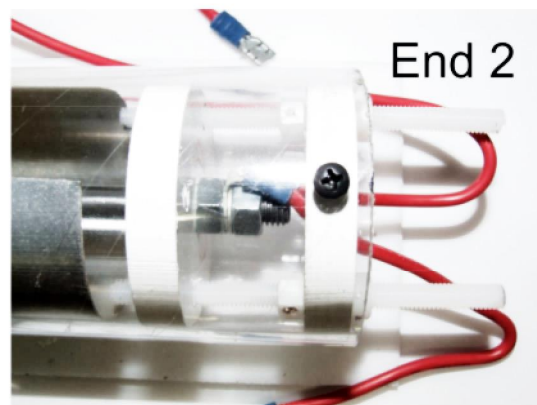
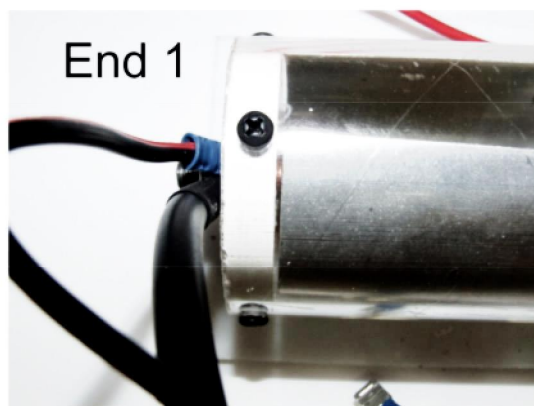

Remove the 3 screws as shown in picture from end 1 And then remove screws from end 2.

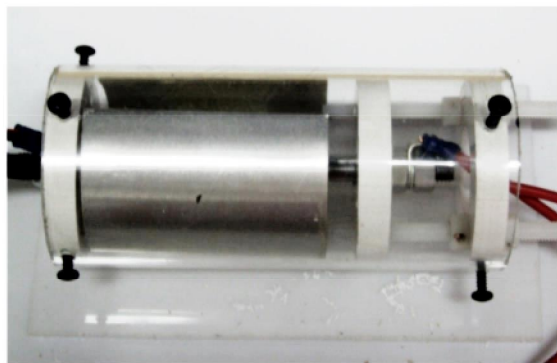

When screws are removed as seen above ,please proceed to page 2.

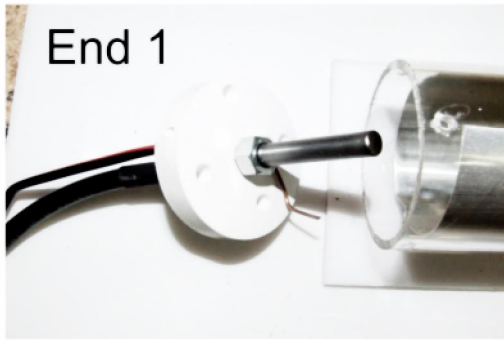

Gently pull end 1 out, take notice of where the copper wire is inserted in the sleeve as it must be replaced the same

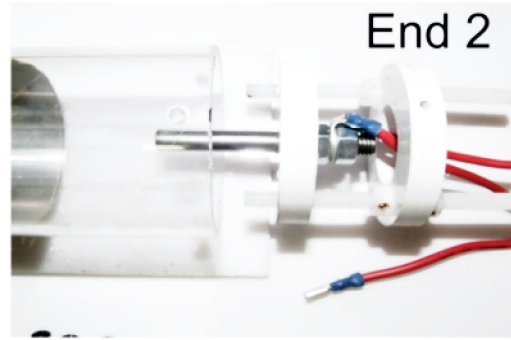

Repeat the same as end 1.

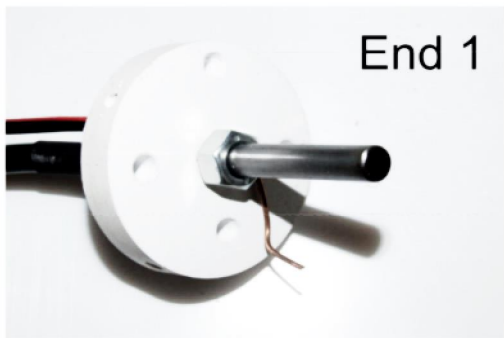

Once you have removed end 1, clean the shaft with a wire brush and make sure the end of the rod is clean and new metal is visible, this can be done with a grinder or sandpaper.

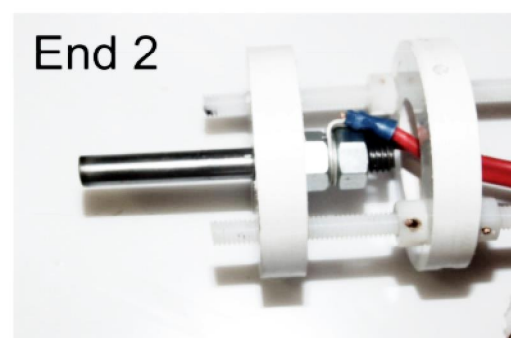

Repeat the same cleaning process for end 2



Remove the sleeve, this can be pushed out using your fingers, clean the sleeve with sandpaper or steel wool.



When finished this is what you should have.

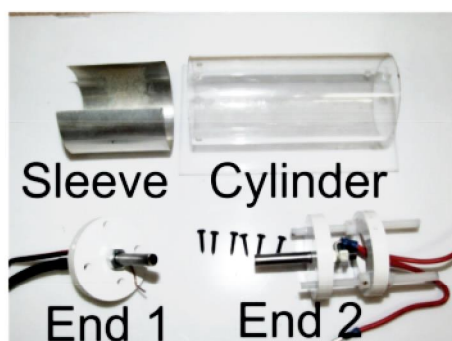

Parts reference



Clean the cylinder with warm soapy water and dry off thoroughly (do not use cold water or hot water as this will crack the cylinder)

# Re-assembling of the Spark Gap

Page 3

Follow these steps below

